

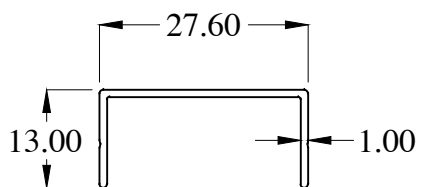

# AIR - CON GRILLE

NO.	PROFILE NO.	WEIGHT (kg / m)	AP (mm)	LENGTH (m , ft)	DESCRIPTIONS	REMARKS
GROUP 1 - AG						
1	AG1002	0.139	103.69			
2	AG1002-A	0.123	91.69			
3	AG1003	0.127	94.45			
4	AG1003-A	0.110	82.45			
5	AG1004	0.355	112.43			
6	AG1004-A	0.323	100.43			
7	AG1005	0.315	224.39			
8	AG1005-A	0.263	191.21			
9	AG1006	0.283	208.32			
10	AG1007	0.095	71.10			





AG1002  
WT : 0.139 Kg/m

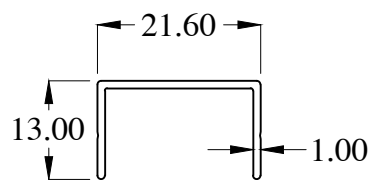

AG1002-A  
WT : 0.123 Kg/m

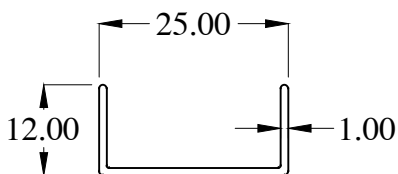

AG1003  
WT : 0.127 Kg/m

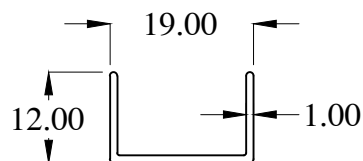

AG1003-A  
WT : 0.110 Kg/m

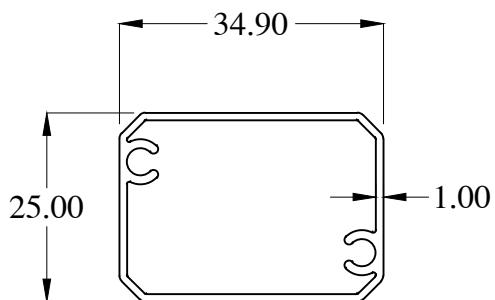

AG1004  
WT : 0.355 Kg/m

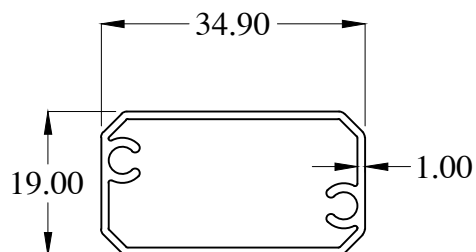

AG1004-A  
WT : 0.323 Kg/m

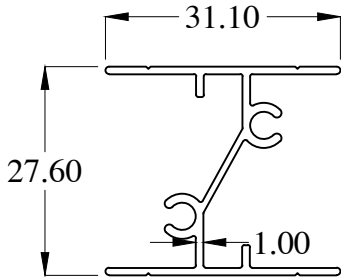

AG1005  
WT : 0.315 Kg/m

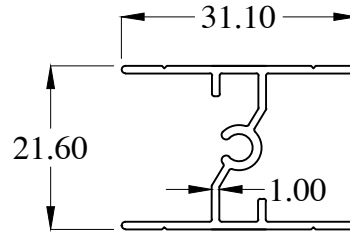

AG1005-A  
WT : 0.263 Kg/m

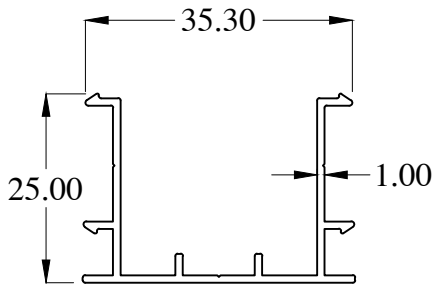

AG1006  
WT : 0.283 Kg/m

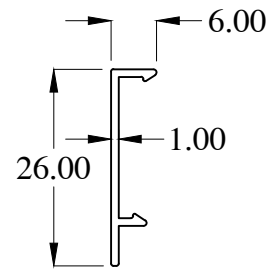

AG1007  
WT : 0.095 Kg/m

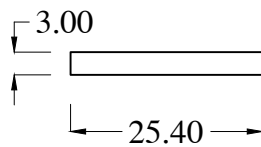

FB08-3  
WT : 0.207 Kg/m

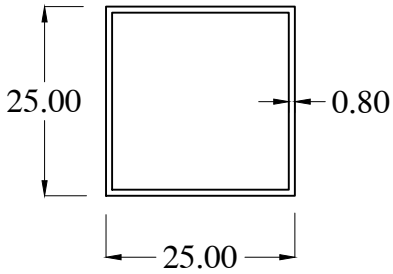

HB0808-1  
WT : 0.213 Kg/m

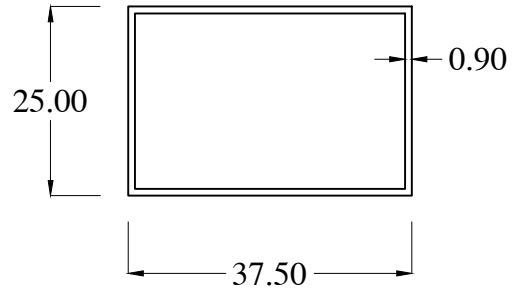

HB0812-1  
WT : 0.301 Kg/m

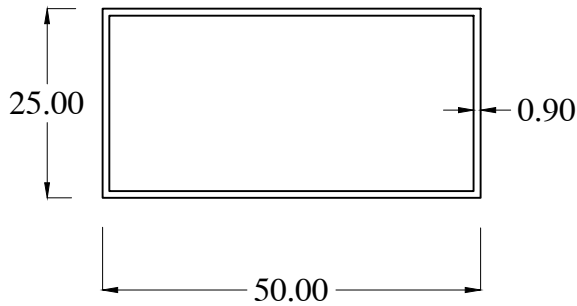

HB0816-1  
WT : 0.363 Kg/m

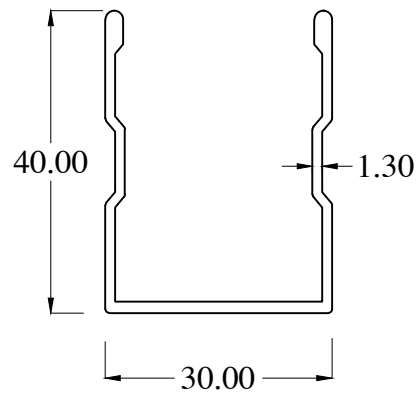

RS12-1  
WT : 0.468 Kg/m

