

PARTITION

DATE : 04.11.20

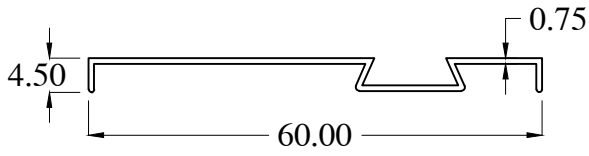

NO.	PROFILE NO.	WEIGHT (kg / m)	AP (mm)	LENGTH (m , ft)		DESCRIPTIONS	REMARKS
1	KP1031	0.160	156.96				
2	KP1031-1	0.141	149.07				
3	KP1032-2	0.079	87.94				
4	KP1035	0.411	341.15				
5	KP1045	0.378	347.66				
6	KP5033	0.210	189.50				
7	KP5033-1	0.185	189.30				
8	KP5038	0.300	277.58				
9	KP5039	0.277	256.51				
10	KP5039-1	0.244	257.20				



KP1031
WT : 0.160 Kg/m

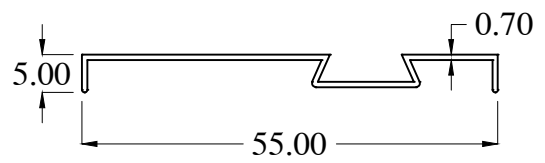

KP1031-1
WT : 0.141 Kg/m

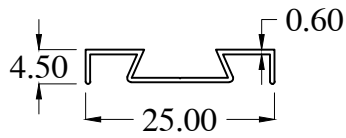

KP1032-2
WT : 0.079 Kg/m

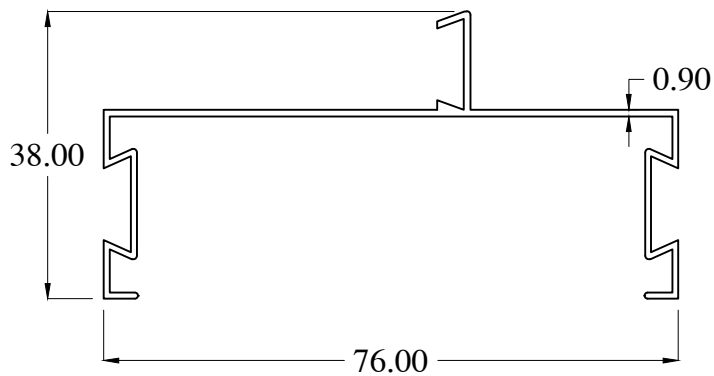

KP1035
WT : 0.411 Kg/m

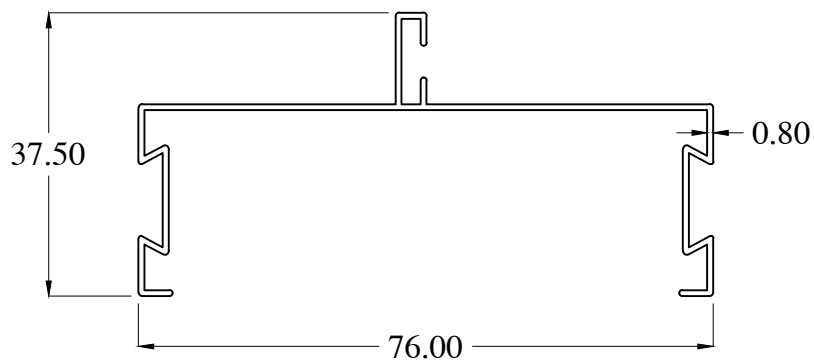

KP1045
WT : 0.378 Kg/m

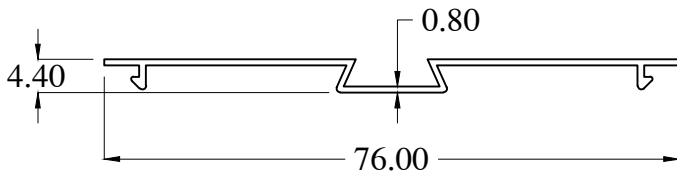

KP5033
WT : 0.210 Kg/m

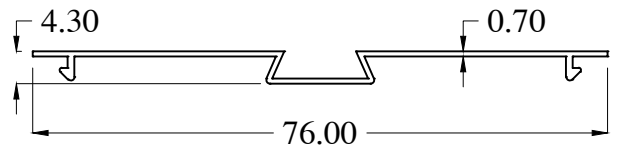

KP5033-1
WT : 0.185 Kg/m

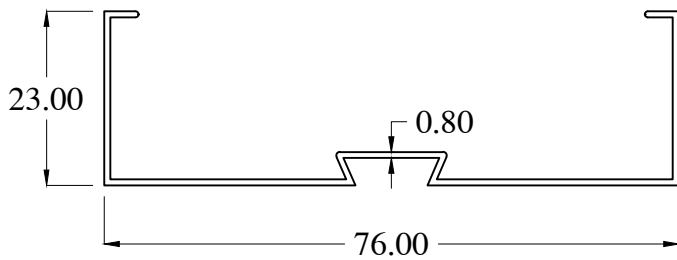

KP5038
WT : 0.300 Kg/m



KP5039
WT : 0.277 Kg/m

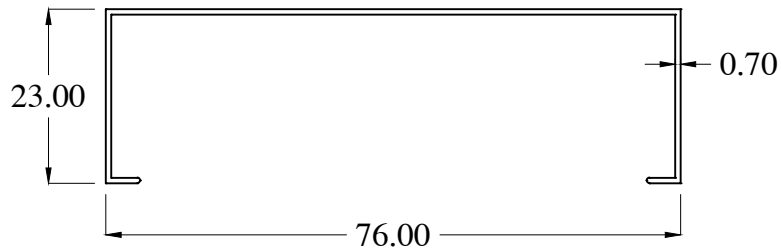

KP5039-1
WT : 0.244 Kg/m

