

NO.	PROFILE NO.	WEIGHT (kg / m)	AP (mm)	LENGTH (m , ft)	DESCRIPTIONS	REMARKS
1	HB0408-1	0.158	75.00			
2	MY1345	0.169	85.00			
3	MY1349	0.276	120.27			
4	MY1359	0.176	92.20			
5	MY1373	0.149	141.41			
6	MY1374	0.199	181.41			
7	MY1384	0.188	105.21			
8	MY1385	0.292	137.21			
9	MY1385-A	0.279	125.00			
10	MY1406	0.563	194.92			

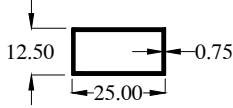

SUB - FRAME

NO.	PROFILE NO.	WEIGHT (kg / m)	AP (mm)	LENGTH (m , ft)		DESCRIPTIONS	REMARKS
11	MY1407	0.105	68.05				

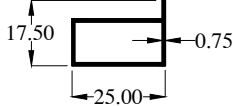
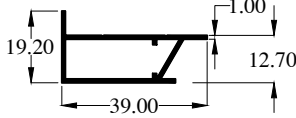
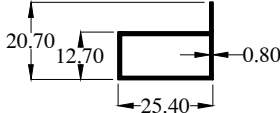
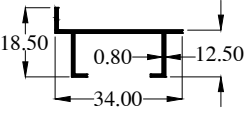
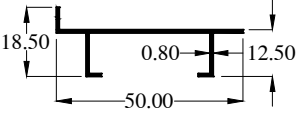
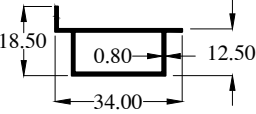
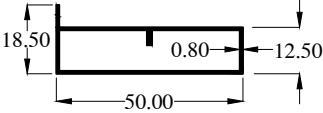
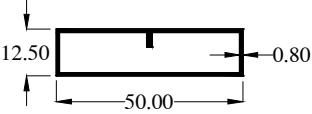
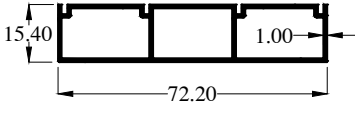
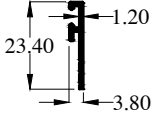
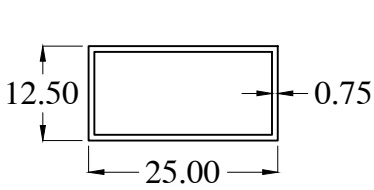

HB0408-1
WT : 0.158 Kg/m

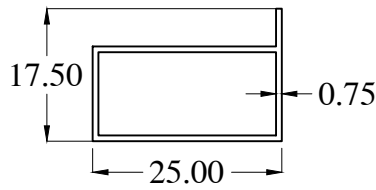

MY1345
WT : 0.169 Kg/m

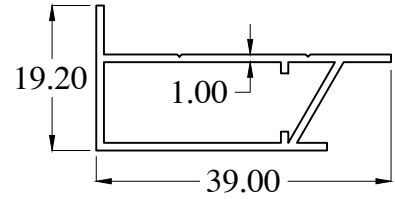

MY1349
WT : 0.276 Kg/m

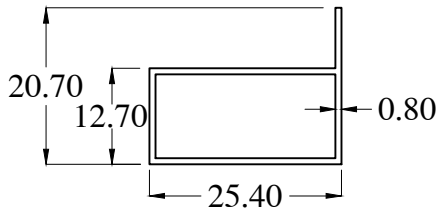

MY1359
WT : 0.176 Kg/m

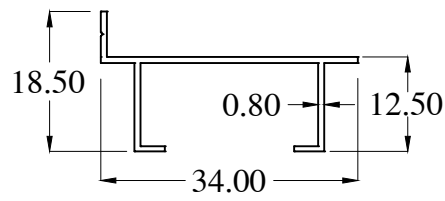

MY1373
WT : 0.149 Kg/m

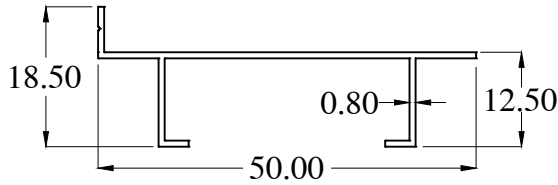

MY1374
WT : 0.199 Kg/m

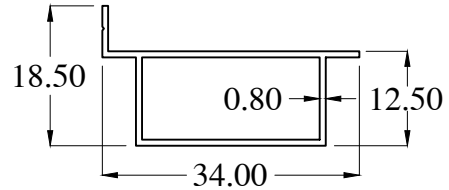

MY1384
WT : 0.188 Kg/m

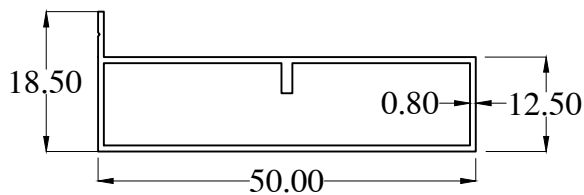

MY1385
WT : 0.292 Kg/m

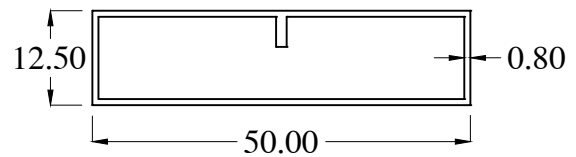

MY1385-A
WT : 0.279 Kg/m

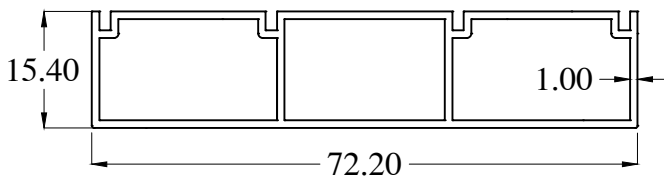

MY1406
WT : 0.563 Kg/m

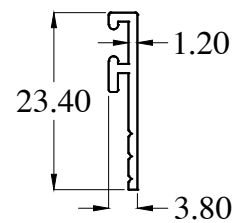

MY1407
WT : 0.105 Kg/m

INSIDE

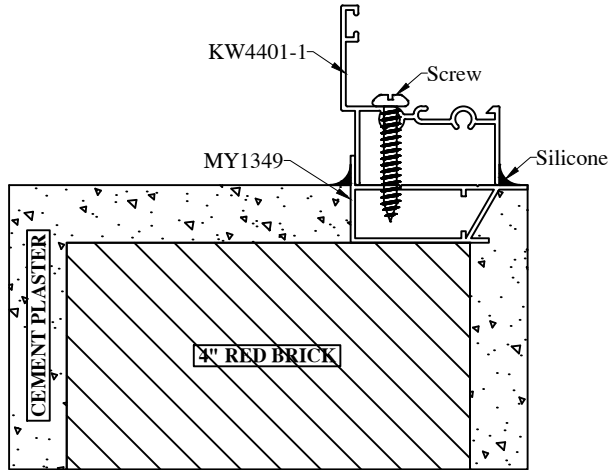

39MM PROFILE
SUBFRAME INSTALLATION
SECTION VIEW

INSIDE

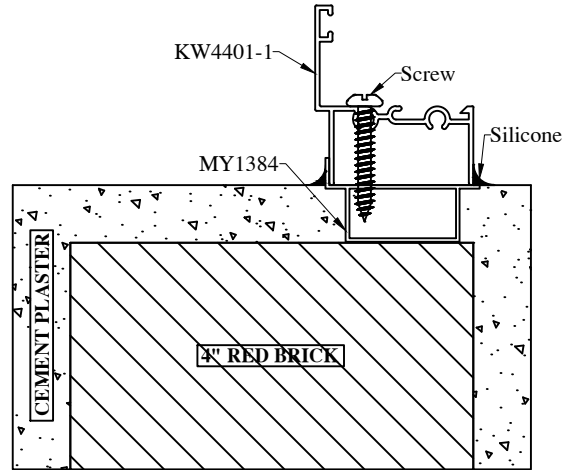

25.4MM PROFILE
SUBFRAME INSTALLATION
SECTION VIEW

INSIDE

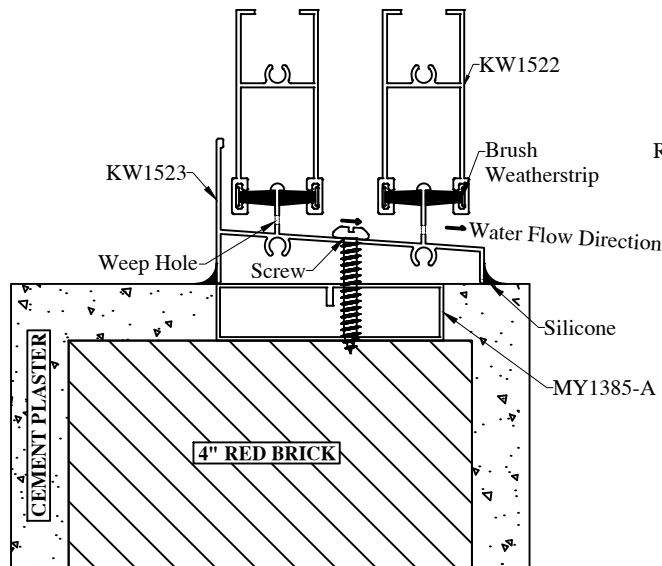

50MM PROFILE
SUBFRAME INSTALLATION
SECTION VIEW

INSIDE

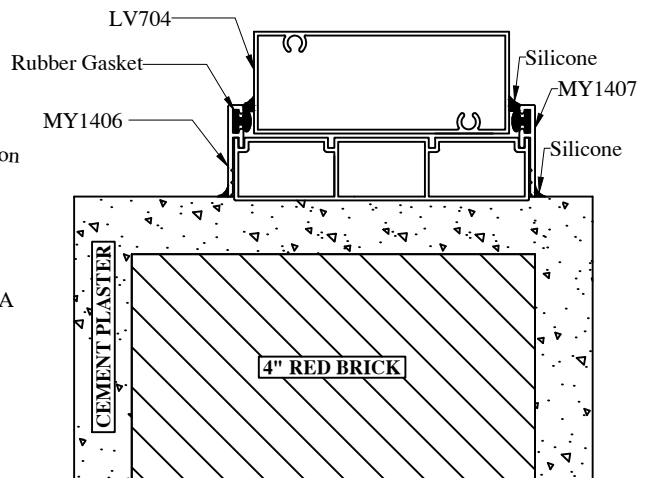

63.5MM & 76.2MM PROFILE
SUBFRAME INSTALLATION
SECTION VIEW